

# CORDOLO 12/15x30x100

## CARATTERISTICHE GENERALI

DIMENSIONI (S x H x L)	12/15x30x100 cm
PESO	±90 kg/cad
FABBISOGNO	1 pz/ml
METODO DI INCASTRO	GIUNTO MASCHIO/FEMMINA
DENSITA' IMPASTO	≥2200 kg/m <sup>3</sup>

## CARATTERISTICHE TECNICHE (UNI EN 1340)

RESISTENZA CARATTERISTICA A FLESSIONE	CLASSE 1 – MARCATURA S ≥3.5 MPa
RESISTENZA ALLO SCIVOLAMENTO	SODDISFACENTE
RESISTENZA ABRASIONE	CLASSE 3 – MARCATURA H ≤23 mm
ASSORBIMENTO ACQUA PER IMMERSIONE	CLASSE 2 – MARCATURA B ≤ 6%
RESISTENZA GELO/DISGELO	CLASSE 3 – MARCATURA D ≤1 kg/m <sup>2</sup>
EMISSIONE DI AMIANTO	NESSUN CONTENUTO
CONTENUTO MATERIA RICICLATA	≥5% (UNI EN ISO 14021:2016)

## COLORI / FINITURE / IMBALLO

FINITURE	QUARZO / GRANITICA / PIETRA
COLORI	GRIGIO
TIPO IMBALLO	PALLETS
QUANTITA' IMBALLO	15 pz
PESO IMBALLO	±1.35 ton

## CERTIFICAZIONI & PRESTAZIONI



UNI EN 1340



Resistente all'abrasione



Resistente al gelo/disgelo



Prestazioni ECO

## COMPOSIZIONE TIPO PER URBANIZZAZIONI

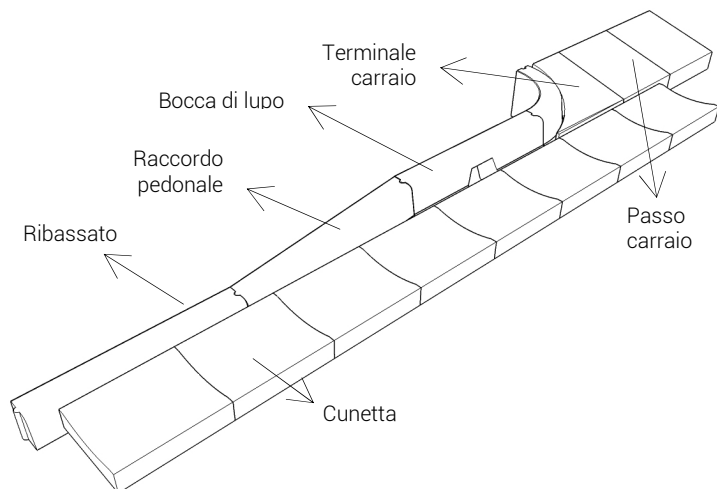

## VISTA ELEMENTI & POSA IN OPERA

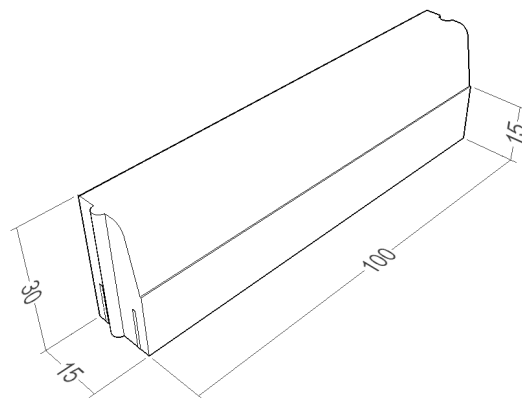

## ACCESSORI DISPONIBILI

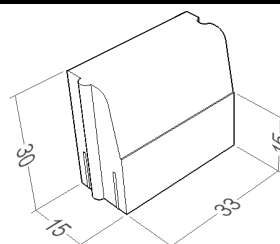

MODULO 33

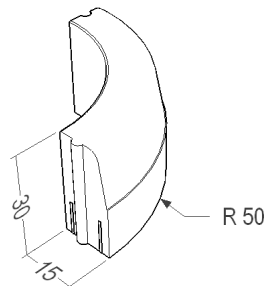

CURVA R=50cm  
(misurato all'esterno  
del cordolo)

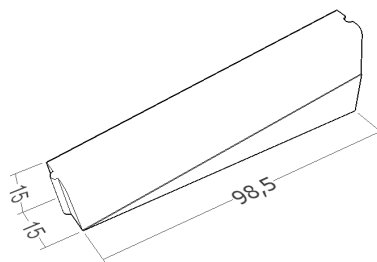

RACCORDO  
PEDONALE  
DX

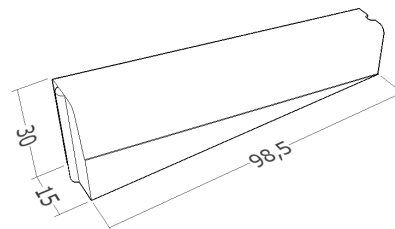

RACCORDO  
PEDONALE  
SX

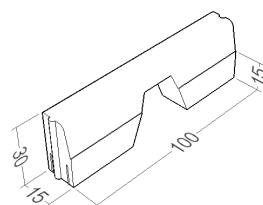

BOCCA DI LUPO

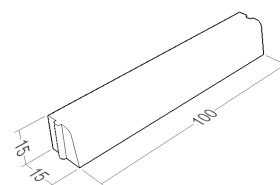

RIBASSATO