

CARATTERISTICHE GENERALI

SPESORE	8 cm
PESO PAVIMENTAZIONE	±160 kg/m ²
GEOMETRIA	22x22,3 cm
FABBISOGNO	±31 pz/m ²
DENSITA' IMPASTO	≥2200 kg/m ³
FORATURA	12%
LARGHEZZA GIUNTI	1 cm (*)
CAPACITA' DRENANTE (Cdre)	100% (**)
COEFFICIENTE DI DEFLUSSO (ψ)	0.00 (***)

(*) A norma barriere architettoniche: larghezza fughe <2cm (art. 8.2.2 del DM 236/89)
 (**) Fonte: Manuale Assobeton Drenanti – Volume 3 - Linee guida per la determinazione della capacità drenante delle pavimentazioni modulari in calcestruzzo (Ed. Ottobre 2011)
 (***) Per eventi di forte intensità (200mm/h durata 10'), media intensità (100mm/h durata 20') e debole intensità (20mm/h durata 24h accumulo 480mm/gg). La piovosità media nazionale è 50÷200mm/gg. (Rif. report RT003_16).

CARATTERISTICHE TECNICHE (UNI EN 1338)

TRAZIONE INDIRECTA PER TAGLIO	≥3.6 MPa
CARICO ROTTURA	≥250 N/mm
RESISTENZA SCIVOLAMENTO	USRV>60
RESISTENZA ABRASIONE	Li≤20mm (CLASSE 4 – MARCATURA I)
ASSORBIMENTO ACQUA	Wa≤6% (CLASSE 2 – MARCATURA B)
RESISTENZA GELO/DISGELO	L≤1kg/m ² (CLASSE 3 – MARCATURA D)

ALTRE CARATTERISTICHE TECNICHE

RESISTENZA SCIVOLAMENTO B.C.R.A.	Attrito eccellente μ≥0.74 (****)
RESISTENZA GELO/DISGELO	DM30 <600g/mq - ALTA RESISTENZA (NORMA SIA 162/1 - PROVA n°9)
EMISSIONE DI AMIANTO	NESSUN CONTENUTO
SOLAR REFLECTANCE INDEX	SRI≥29% (COLORI SOLAR+)
CONTENUTO MATERIA RICICLATA	≥5% (UNI EN ISO 14021:2016)

(****) A norma barriere architettoniche: coeff. attrito >0.4 (art. 8.2.2 del DM 236/89)

COLORI / FINITURE / IMBALLO

FINITURE	QUARZOPORFIDO
COLORI	NERO / GRIGIO / ROSSO
TIPO IMBALLO	PALLETS
QUANTITA' IMBALLO	9 m ²
PESO IMBALLO	±1.47 ton

CERTIFICAZIONI & PRESTAZIONI

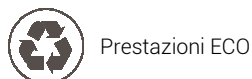
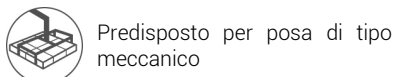
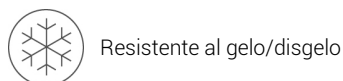
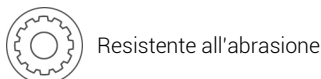

VISTA ELEMENTI & POSA IN OPERA

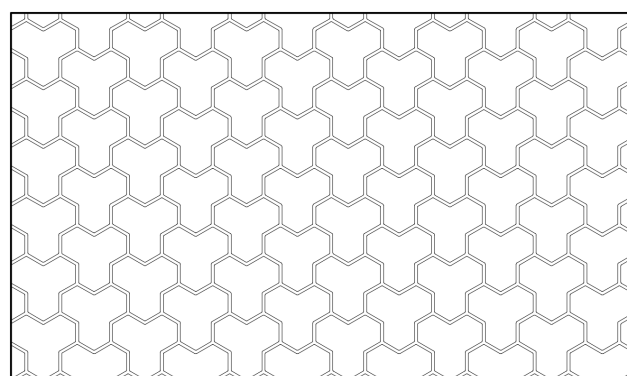
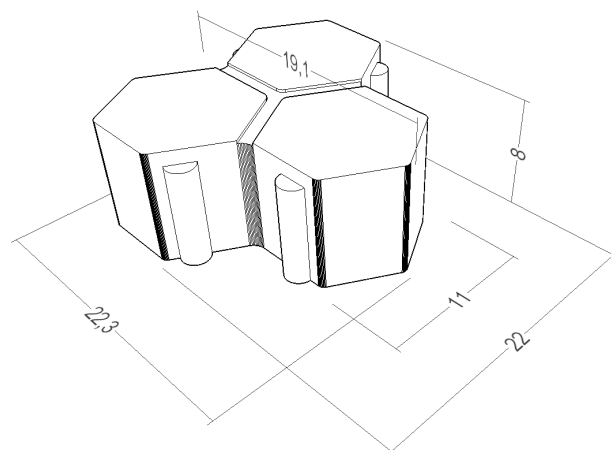

Posa "A Correre"

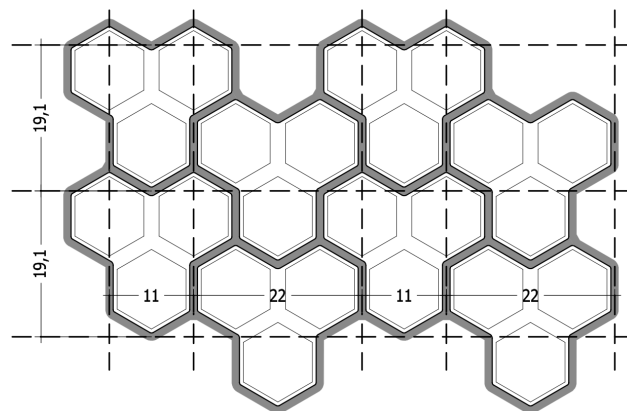

Modulo di posa

Richiedi il report drenanti a ufficiotecnico@ferraribk.it